

FEATURES

- The preferred pump frame in the pressure cleaning industry
- Forged brass manifold with an exclusive lifetime warranty
- Large-capacity, die-cast, anodized aluminum oil-bath crankcase
- Over-sized connecting rods for maximum life
- Heavy-duty tapered roller bearing.
- Solid ceramic plungers with continuously lubricated packings
- Unitized stainless steel inlet and discharge valves
- Available in left-handed "L" version



SPECIFICATIONS

Pump Model	TS921	TS1321	TS1621-N
Maximum Volume	4.75 GPM		
Maximum Discharge Pressure	1800 PSI	2100 PSI	2500 PSI
Maximum Pump Speed	1450 RPM		
Maximum Inlet Pressure	125 PSI		
Maximum Inlet Vacuum	9 ft. water (7.9 in. Hg)		
Bore	.866 in. / 22 mm		
Stroke	.472 in. / 12 mm		
Crankcase Oil Capacity	33.8 oz	40.6 oz..	
Maximum Fluid Temperature	165°F		
Inlet Port Thread	1/2-14 BSPP-F		
Discharge Port Thread	3/8-19 BSPP-F		
Shaft Diameter.	.945 in. / 24 mm		
Weight	30 lbs.	32 lbs.	
Dimensions	12.2 x 9.2 x 6.9 in.		

N=Nickel-plated manifold

DIMENSIONAL DRAWING

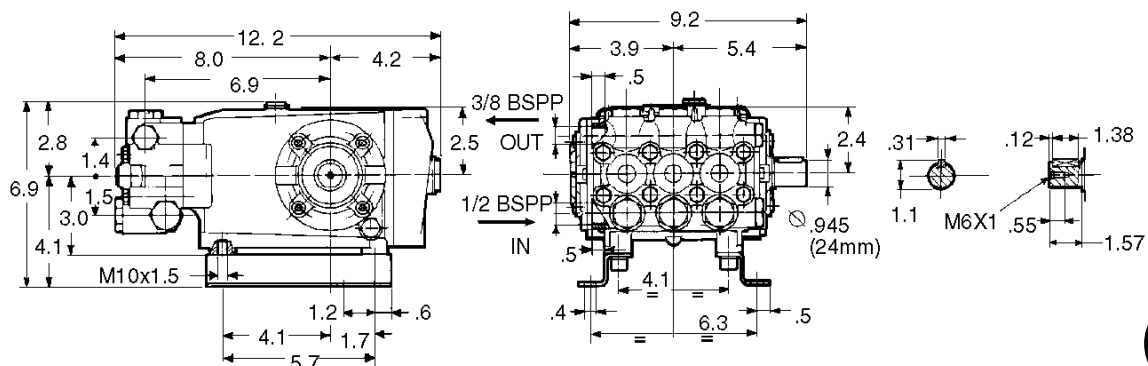

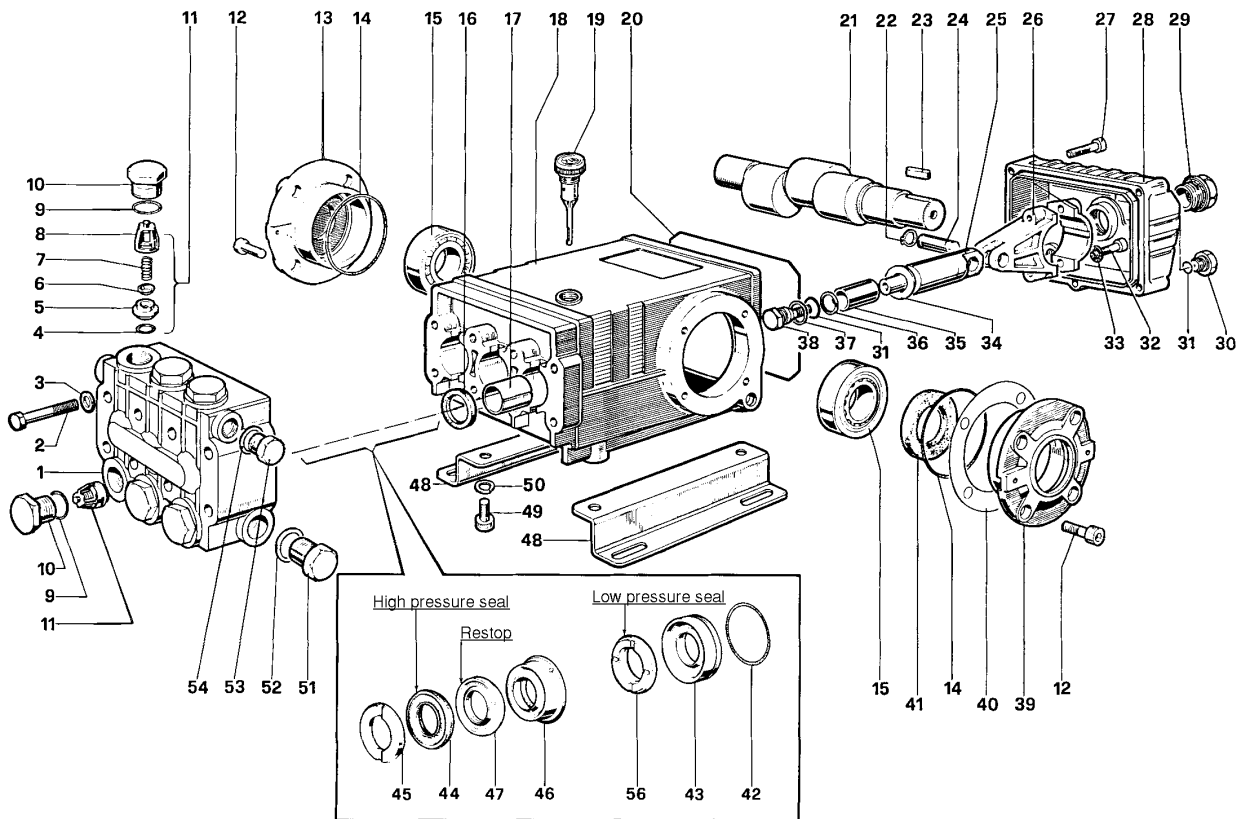

PARTS LIST

ITEM	PART NO.	DESCRIPTION	KIT NO.	QTY.	ITEM	PART NO.	DESCRIPTION	KIT NO.	QTY.	ITEM	PART NO.	DESCRIPTION	KIT NO.	QTY.
1.	47120841	Manifold, Brass		1	19.	98210600	Oil Dip Stick		1	37.	96728000	Washer	6	3
	47120941	Manifold, Nickel-Plated (TS1621-N)		1	20.	90392200	O-Ring, Cover		1	38.	47219566	Screw, Plunger	6	3
2.	99320600	Screw, M8 x 70		8	21.	47021835	Crankshaft		1	39.	47150022	Cover, Crankcase	14, 29	3
3.	96702000	Washer, M8.4		8	22.	90055700	Ring, Snap		6	40.	97567800	Shim	29, 148	3
4.	90384100	O-Ring, .674 x .103	1	6	23.	91489000	Key		1	41.	90164800	Seal, Oil	11, 29	3
5.	36200366	Seat, Valve	1	6	24.	97738000	Pin, Wrist		3	42.	90361600	O-Ring, 1.364 x .070	14, 29	3
6.	36200176	Plate, Valve	1	6	25.	47050554	Guide, Plunger		3	43.	47080670	Retainer, Packing	29, 149	3
7.	94737600	Spring	1	6	26.	47030001	Rod, Connecting		3	44.	90272500	Packing	29, 148	3
8.	36200251	Guide, Valve	1	6	27.	99191200	Screw, M6 x 30		5	45.	46100051	Ring, Head, M22	11, 29	3
9.	90384700	O-Ring, .797 x .103	4, 5	6		99183700	Screw, M6 x 14 (TS921)		1	46.	47217070	Intermed. Ring	29, 149	3
10.	98222000	Cap	4	6	28.	47160122	Cover, Crankcase		1	47.	90273000	Restop Ring	29, 148, 149	3
	98222200	Cap, Ni-Plated (TS1621-N)	5	6		47160022	Cover, Crankcase (TS921)		1	48.	47200074	Pump Feet		2
11.	36703201	Valve Assembly	1	6	29.	97596800	Oil Indicator		1	49.	99364400	Screw, M10 x 18		4
12.	99303900	Screw, M8 x 16		8	30.	98204100	Cap		1	50.	96710600	Washer, M10.2		4
13.	47150122	Cover, Crankcase	1	6	31.	90358500	O-Ring, .426 x .070	6	4	51.	98217600	Cap		1
14.	90391300	O-Ring, 2.675 x .103	2	6	32.	99309900	Screw, M8 x 35		6	52.	96751400	Washer, M21.5		1
15.	640047	Bearing, Roller	2	6	33.	96701400	Washer, M8.4		6	53.	98210000	Cap		1
16.	90162500	Seal, Oil	2	3	34.	96728600	Washer, M14	6	3	54.	96738000	Washer, M17.5		1
17.	90912600	Bushing		3	35.	47040509	Plunger, (22 mm)		3	56.	90272800	Seal, Low Press., 22mm	29, 148	3
18.	47010522	Crankcase		1	36.	90506700	Ring, Back-up	6	3					

REPAIR KITS

KIT NO.	1	2	3	4	5	6	11	14	29	148	149
ITEM NO.s INCLUDED IN KIT	4, 5 6, 7, 8 (11)	16	41	9, 10	9, 10	31, 34, 36, 37, 38	45	42, 43	42, 43, 44, 45, 46, 47, 56	44, 47, 56	46, 47
NUMBER OF ASSEMBLIES IN KIT	6	3	2	6	6	3	6	3	1	3	3
NUMBER OF CYLINDERS KIT WILL SERVICE	3	3	-	3	3	3	3	3	1	3	3

TORQUE SPECS*

Position	Ft.-lbs.
2	22.1
10	73.7
12	14.7
27	7.3
29	13.2
30	14.7
32	14.7
38	14.7
49	29.4
51	29.4
53	29.4

*Decrease torque by 20% if threads are lubricated.